

Alderley

4000x3000

35 mm

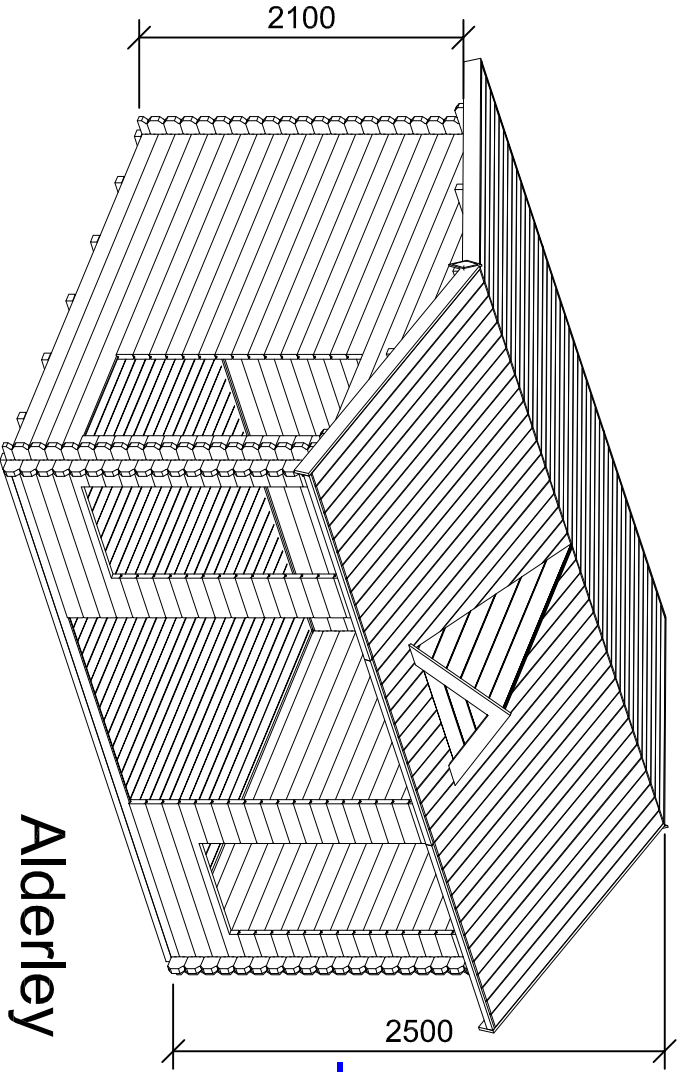
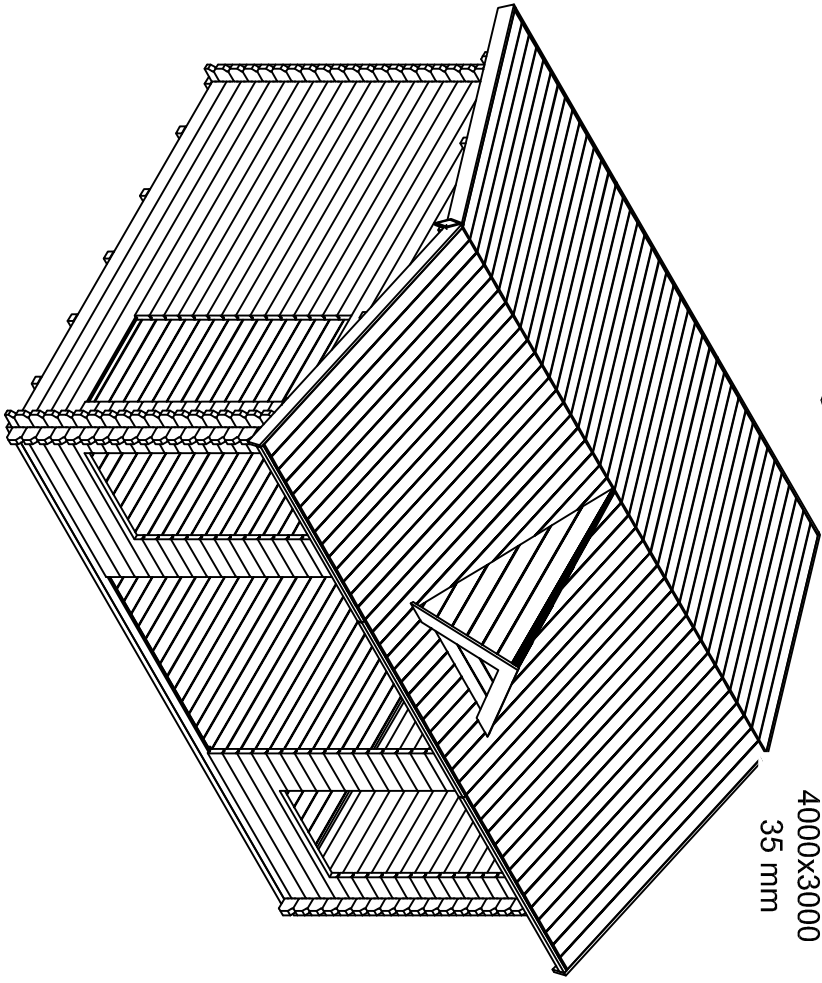

Alderley
4000x3000
35 mm

-B-

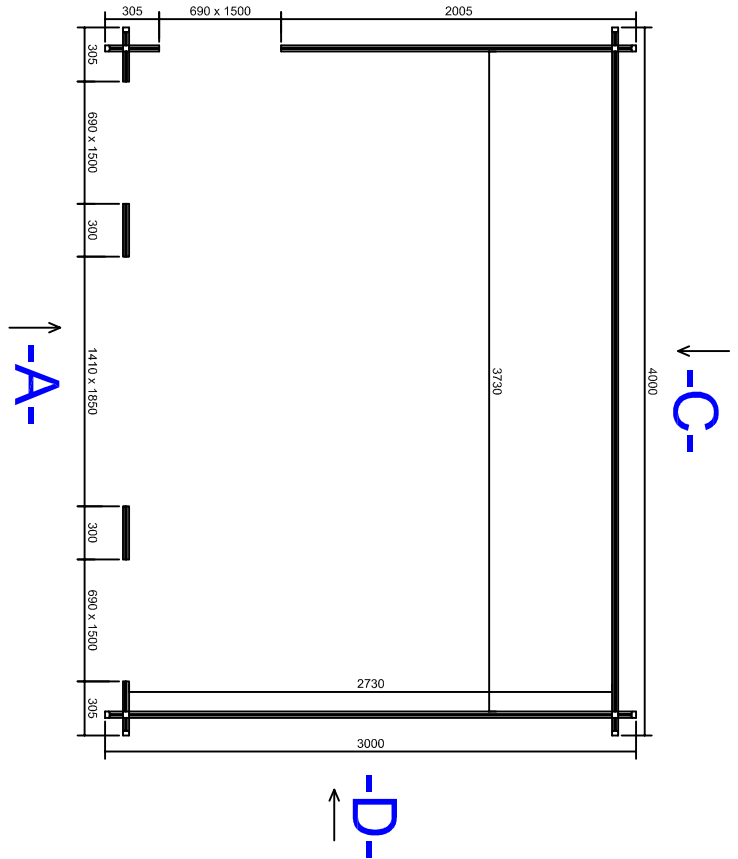

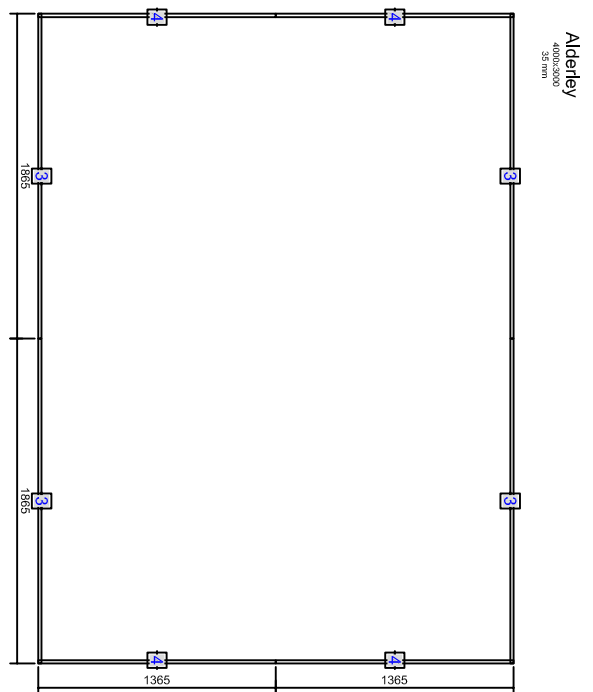
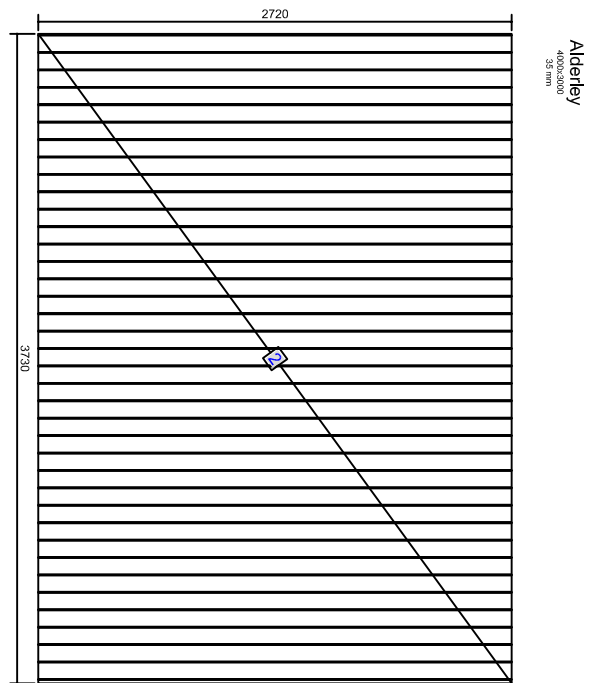
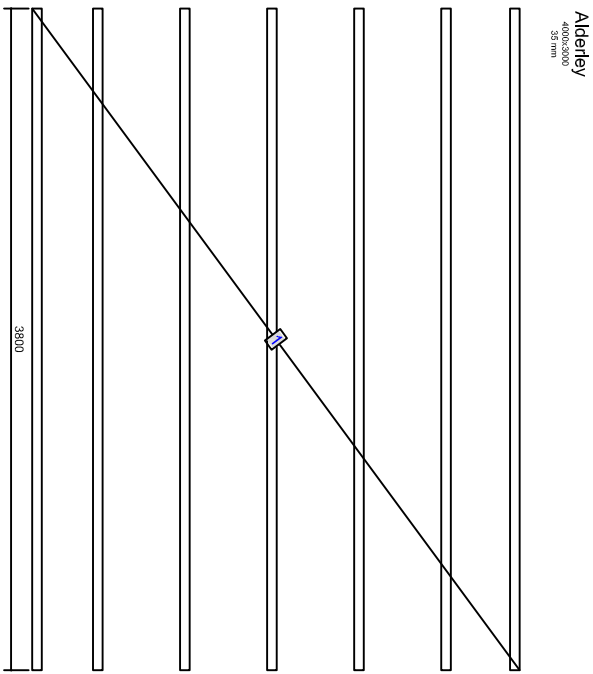

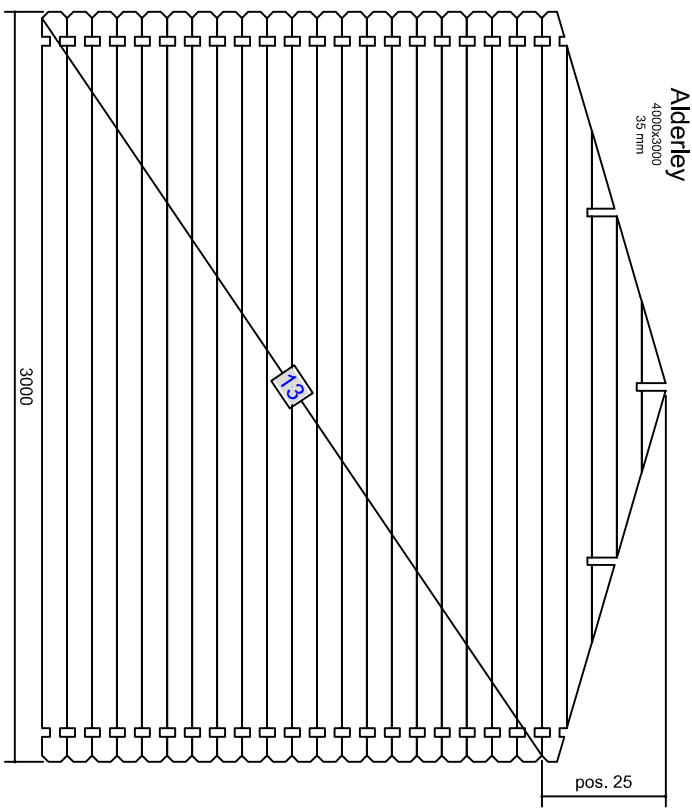
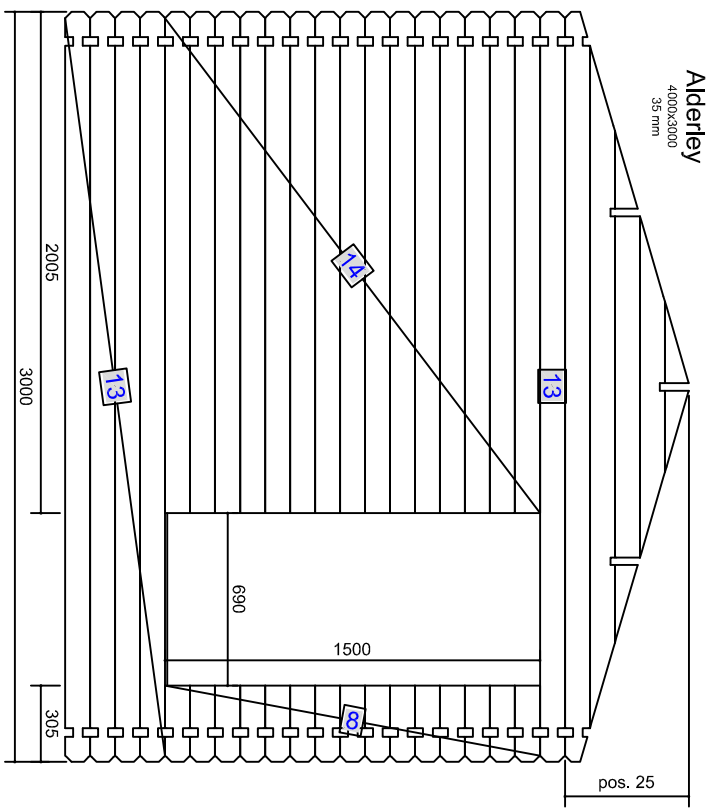
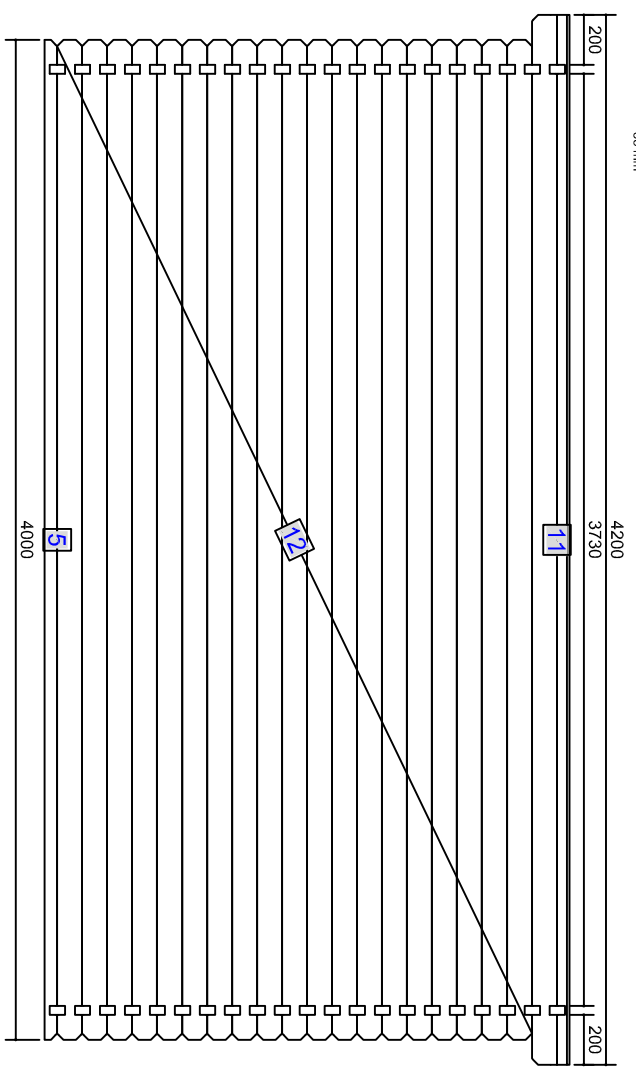
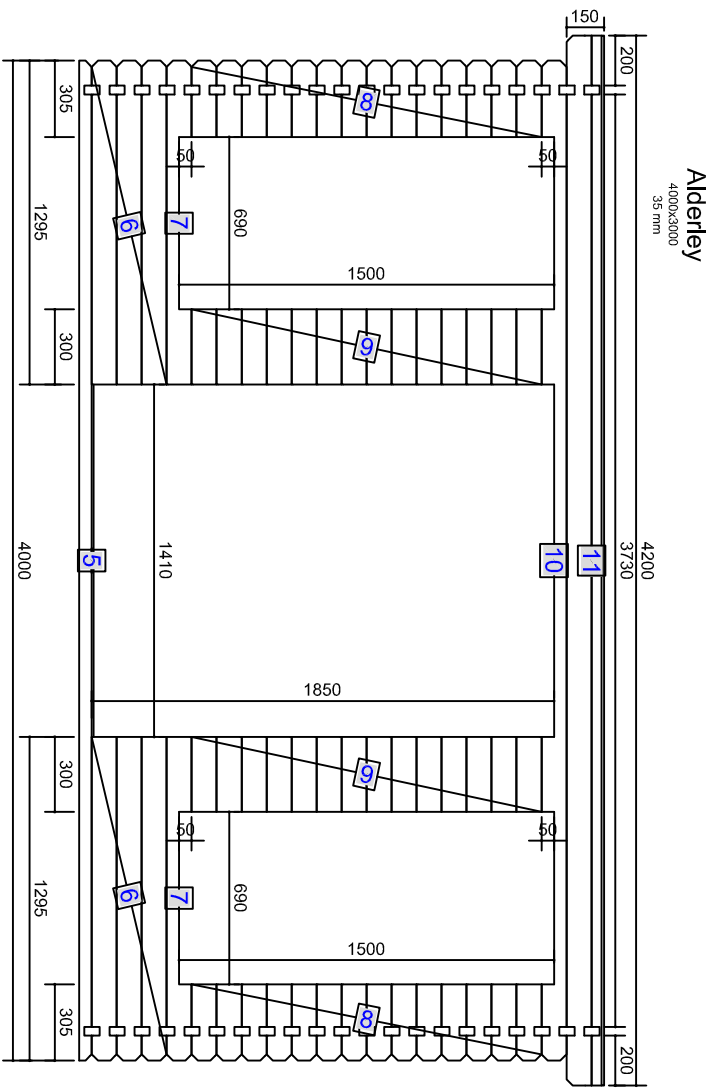

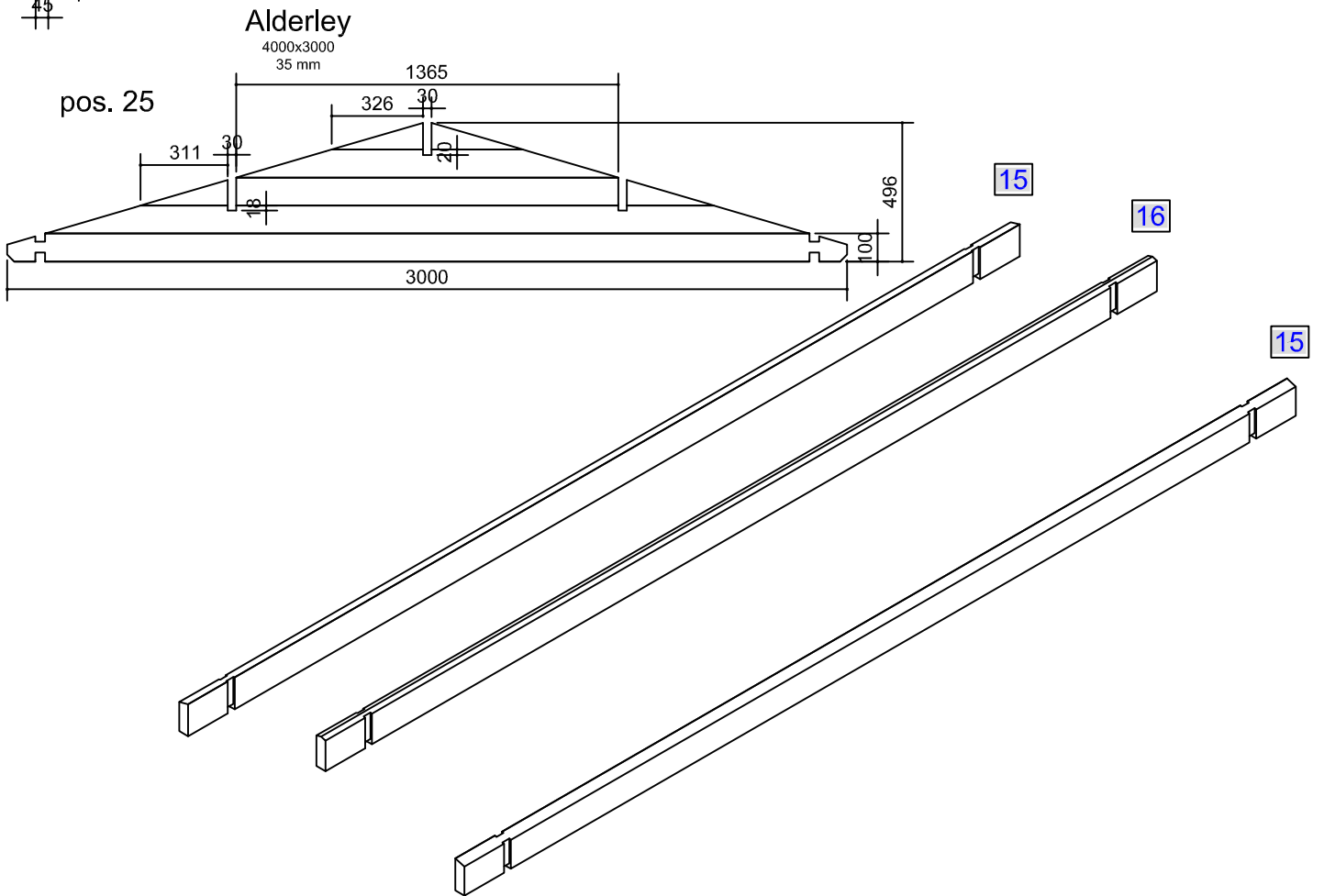
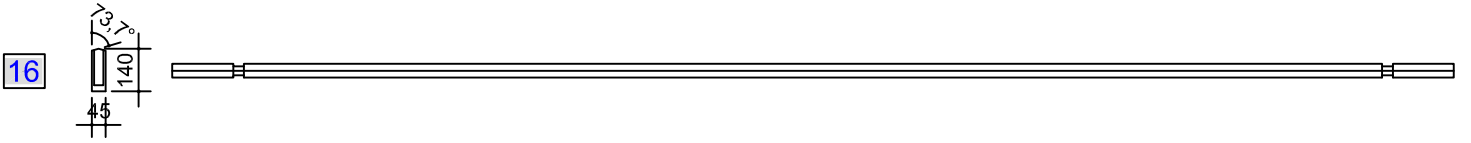
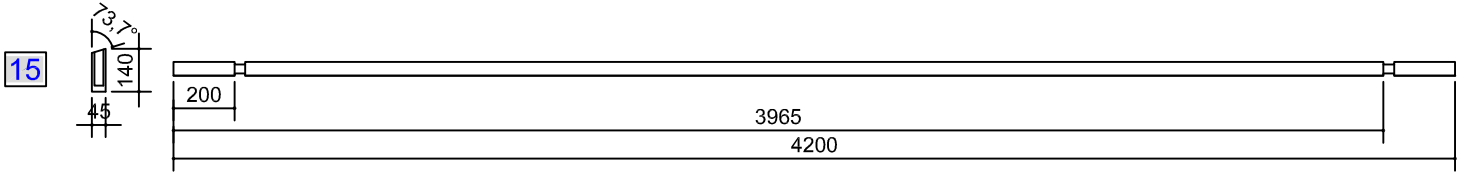

Alderley
4000x3000
35 mm

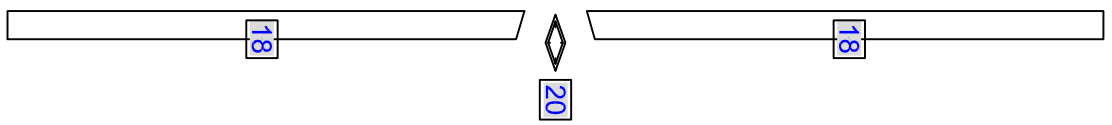
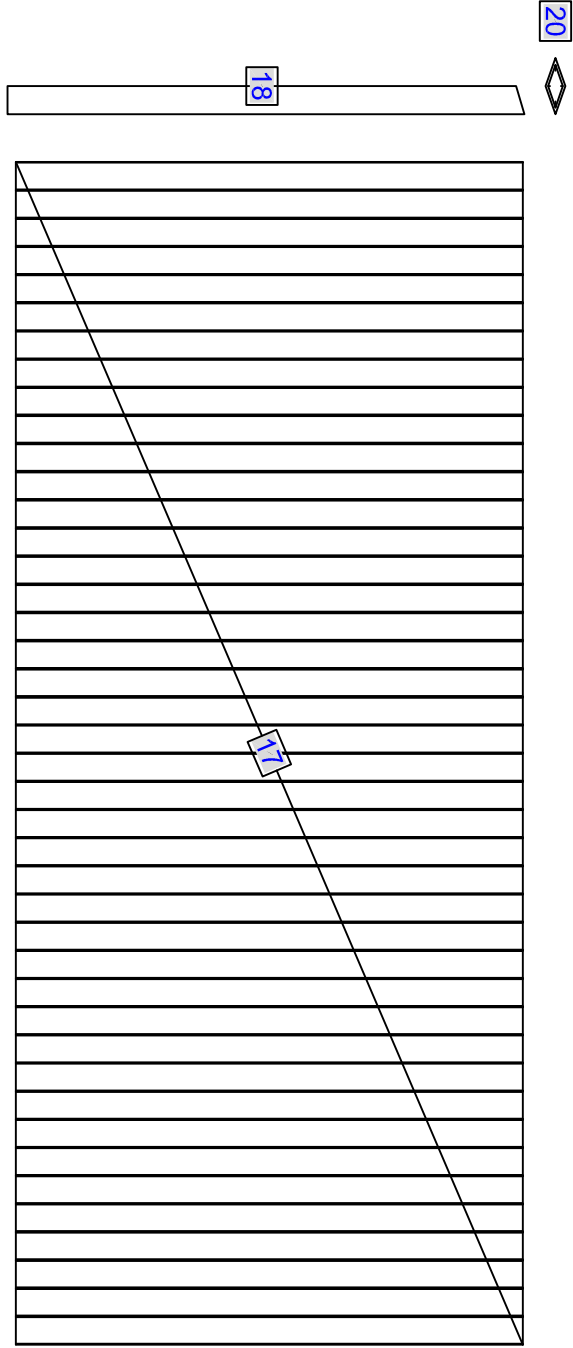
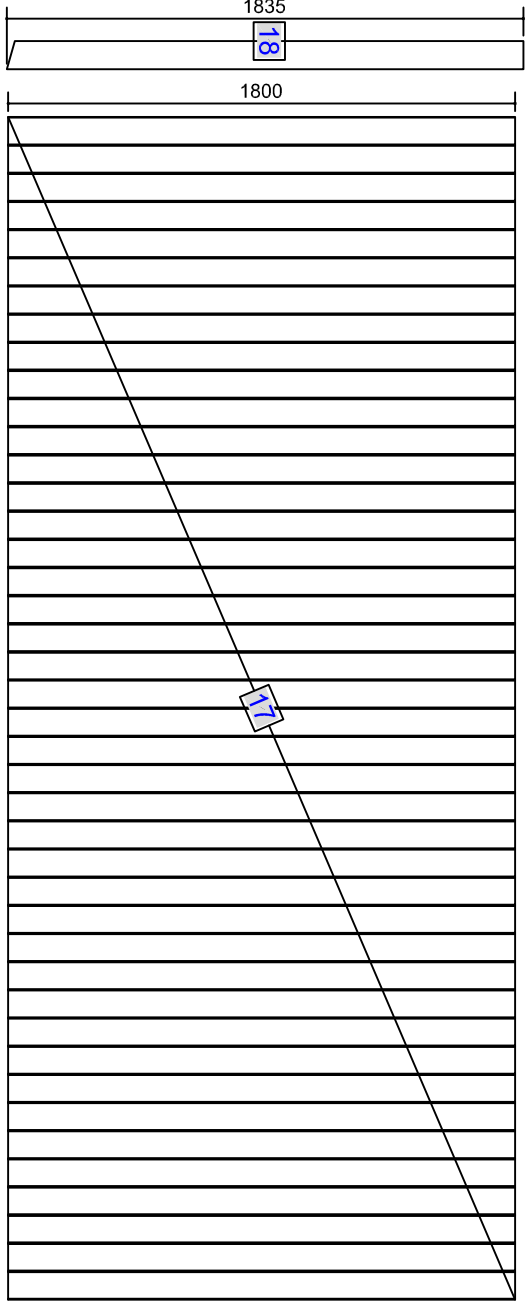
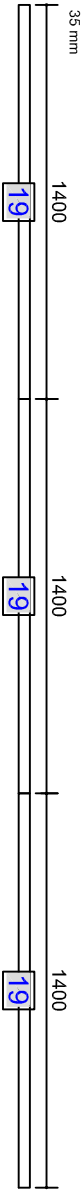

Alderley
4000x3000
35 mm

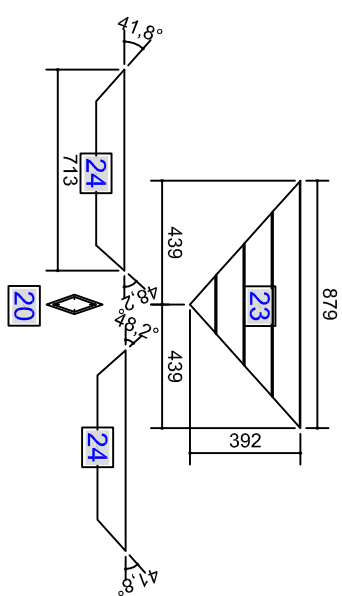
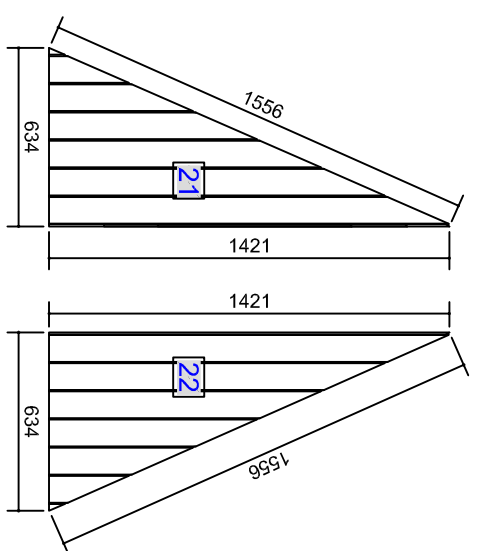









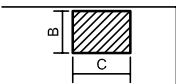
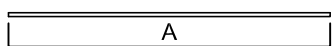
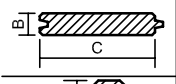
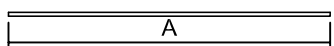
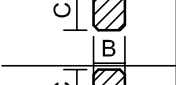
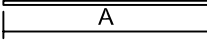

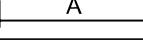
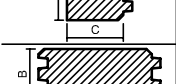
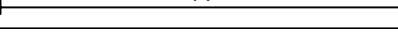
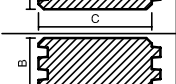
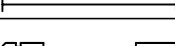
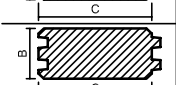

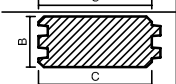

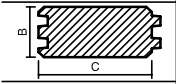
Alderley

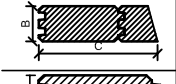
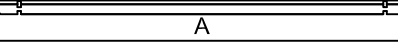
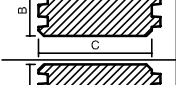
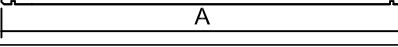
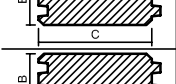
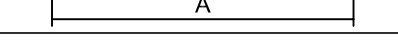
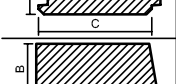
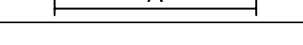
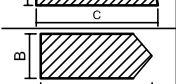
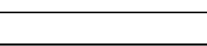
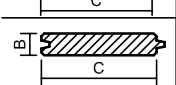
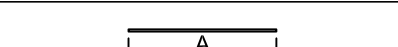
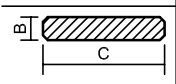
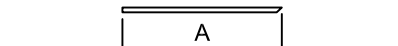
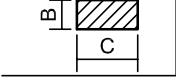
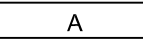
400x300 cm
35x100 mm

BE 2011

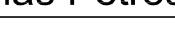
-Date-

Degree < 73,7	Dimensions, mm			Pos.	Quantity		
	A	B	C				
		3800	40	55	1	7	-Packing Nr.-
		2720	19	100/86	2	38/44	
		1865	19	24	3	4	
		1365	19	24	4	4	
		4000	35	50	5	2	
		1295	35	100	6	6	-Name, last name-
		1295	35	100	7	2	
		305	35	100	8	43	
		300	35	100	9	28	
		4000	35	100	10	1	
		4200	35	150	11	2	-Signature-
		4000	35	100	12	19	
		3000	35	100	13	25	
		2005	35	100	14	15	
		4200	45	140	15	2	
		4200	45	140	16	1	
		1800	19	100/86	17	84/98	
		1835	19	100	18	4	
		1400	19	40	19	6	
		200	70		20	3	

Constructor: Jonas Petrošius

Alderley		400x300 cm			BE 2011	-Date-
		35x100 mm				
Degree < 73,7	Dimensions, mm			Pos.	Quantity	
	A	B	C			
	1421	634		21	1	-Packing Nr.-
	1421	634		22	1	
	879	392		23	1	
	713	19	100	24	2	-Name, last name-
	3000	496		25	2	
	1410	1850		26	1	
	690	1500		27	3	
	~1880	40	19	28	4	
	1835	19	40	29	4	-Signature-
	1510	45	28	30	2	
	790	45	28	31	6	
Constructor: Jonas Petrošius					Page 2	